

Nominal data

Type	414 J	
Nominal voltage	VDC	24
Nominal voltage range	VDC	18 .. 27
Speed	min ⁻¹	10300
Power input	W	2.4
Min. ambient temperature	°C	-20
Max. ambient temperature	°C	70
Air flow	m ³ /h	19
Sound power level	B	5.5
Sound pressure level	dB(A)	39

ml = Max. load · me = Max. efficiency · fa = Running at free air · cs = Customer specs · cu = Customer unit
Subject to alterations

Technical features

Mass	0.050 kg
Dimensions	40 x 40 x 25 mm
Material of impeller	Fiberglass-reinforced PA plastic
Housing material	Fiberglass-reinforced PBT plastic
Direction of air flow	Air exhaust over bars
Direction of rotation	Left, looking at rotor
Bearing	Ball bearings
Lifetime L10 at 40 °C	60000 h
Lifetime L10 at maximum temperature	30000 h
Connection line	Single strands AWG 26, TR 64, bared and tin-plated.
Motor protection	Protected against reverse polarity and locking.
Approval	VDE, CSA, UL

414 J

DC axial compact fan

Product drawing

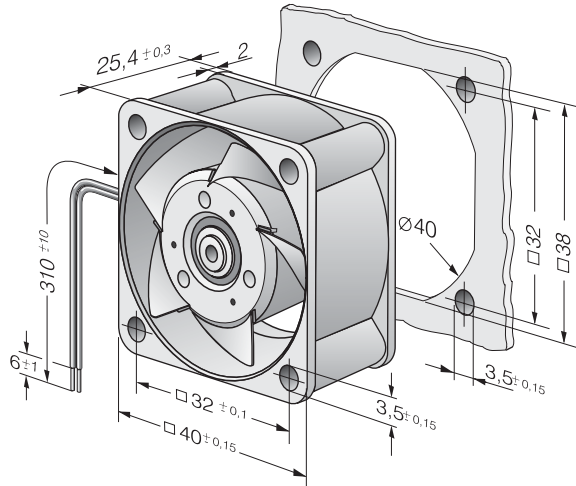

Charts: Air flow

